



V5X

C-TYPE 5-AXIS VERTICAL
MACHINING CENTER



WE ARE AXILE

AXILE designs and builds agile smart 5-axis VMCs with leading automation solutions for manufacturers of complex parts and components.

“ We believe manufacturers shouldn’t have to choose between high-speed and high-performance 5-axis machines. ”

By combining sheer agility, digitalized intelligent automation, and a new standard of 5-axis machining, we’ve created an all-new approach:

Agile Smart Machining.

In short, our dedicated team of industry experts brings together ultra-high removal rates, pinpoint precision, and 24/7 automation and reliability within each and every AXILE 5-axis machine.

Our breakthrough design concepts and advanced proprietary technologies serve highly sophisticated manufacturers of complex parts and components for applications in aerospace, die and mold, medical, and general job shop, among others.

The AXILE service and support network spans nearly 50 countries, with more than 70 distributors across Asia, Europe, and the Americas, and a service center in Croatia.



CONTENTS

4 V5X C-TYPE VMC

DESIGN CONCEPT

AGILITY

ACCURACY

SPINDLE

CHIP & TOOL MANAGEMENT

ERGONOMICS

CONTROL UNIT

14 STANDARD & OPTIONAL EQUIPMENT

15 TECHNOLOGIES

SMT™

ART™

18 LAYOUT AND WORKSPACE

19 TECHNICAL DATA

V5X C-TYPE VMC

The compact V5X comes in dry or wet cut for small graphite or metal workpieces, respectively. The V5X Graphite features a built-in dust collector vacuum, while the V5X Metal offers efficient chip management.



V5X Graphite machining type



V5X Metal machining type

DESIGN CONCEPT

THE STRUCTURE

1

Flat support for tool magazine directly supported on the floor

No bending of the column and no limitation for bigger, heavier magazines

3

All body made of high-quality casting

Homogeneous thermal behaviour

Optimal damping of machining vibrations

2

C-type proven design

High rigidity of Z-axis and spindle headstock
Same behavior in full X and Y travel

4

Wide distance between Y-axis guides

Best support for saddle and table and stable machining even with heavy loads

5

Integrated rotary-on-rotary 2-axis table

Easy and comprehensive 5X machining kinematic

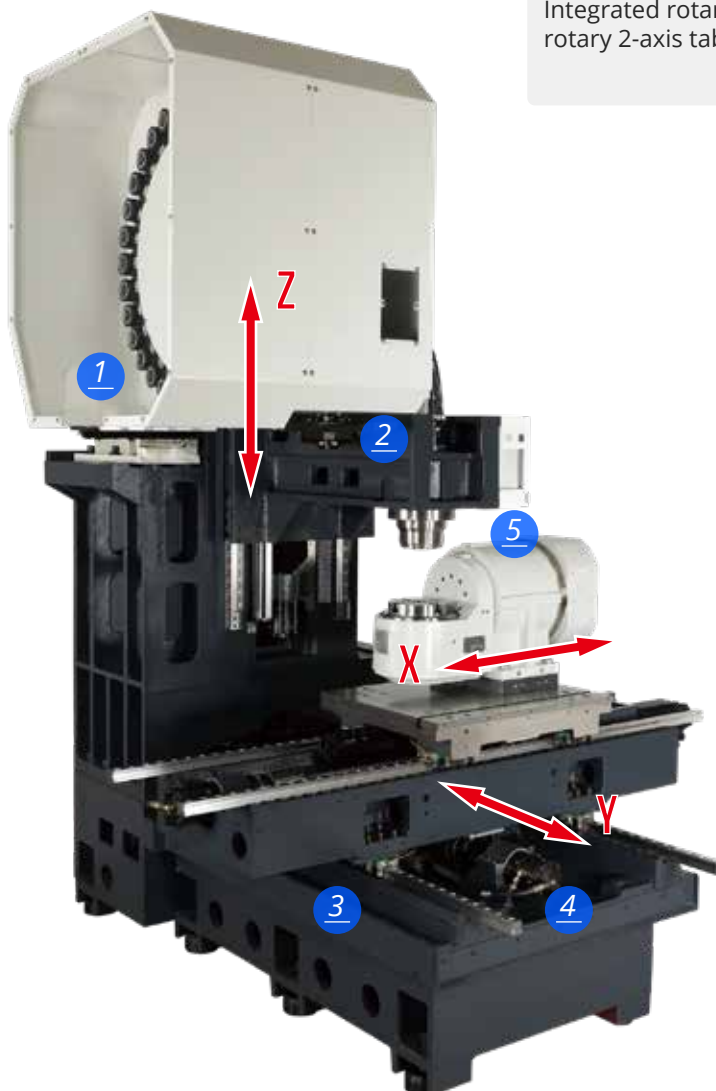

AGILITY

1

Direct driven servomotors (no belts/gears)

Best dynamic and minimal elasticity in the driving chain

5

Roller type liner guideways

Best high-feed movement and vibration damping

2

No counterbalance for Z-axis

Best dynamics using high-power Z-axis servo motor

6

Torque motor-driven rotary axes (A and C)

Highest dynamics and accuracy

3

0,1 μm resolution absolute linear scales in ALL axes

Ensures best accuracy

7

Pneumatic brakes in rotary axes (A and C)

High-repeatability in 5-axis operation

4

Longer guideways to support telescopic covers

Smooth high-speed feed-rates

8

High-resolution direct absolute rotary measuring system

Zero backlash and high accuracy

6



8

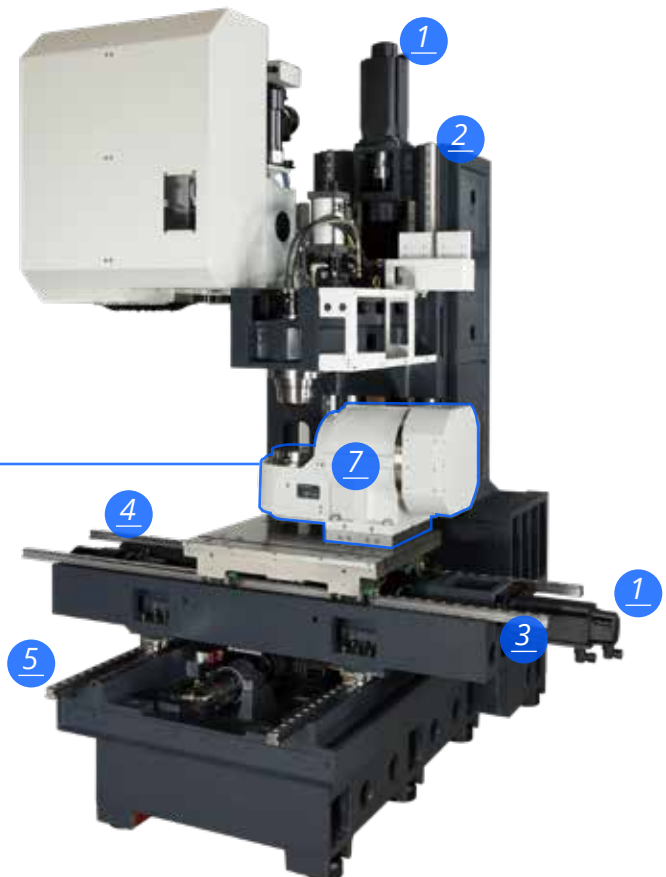
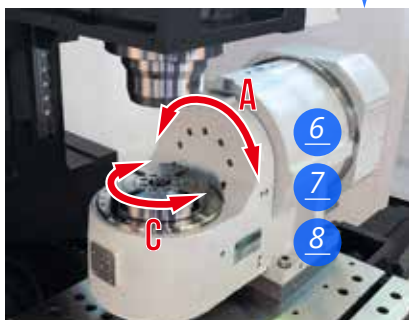

ACCURACY

THE CORNERSTONE OF 5-AXIS MACHINING

Linear axes accuracy

Ballscrew's thermal growth

0.1 μ m resolution
absolute linear scales in
ALL axes



Rotary axes accuracy

Elasticity and backlash of
driving system

Direct-driven torque
motors with no backlash

Angular error is
multiplied by the distance
from rotary axis to
machining point

+/- 5" accuracy absolute
rotary scale feedback



Thermal control

Heat generated by
spindle and torque
motors

Spindle and torque
motors are cooled with a
water chiller close-circuit
and a cooling unit



Linear-rotary axes relative positioning

The swivelling-rotary
table might shift its
relative position to the 3
linear axes by many
reasons generating an
increasing error in the
part

CNC embedded
compensating functions
like Kinematics
(Heidenhain), Kinematic
chain (Siemens) and
Tilted working plane
indexing (Fanuc)



SPINDLE

GRAPHITE MACHINING

> 25.000 rpm > 20/26 kW

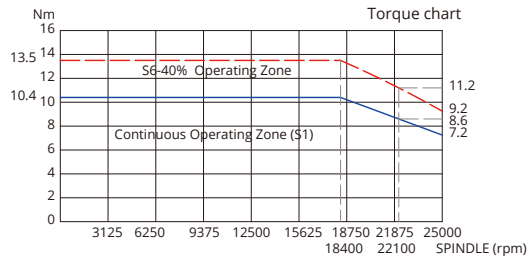
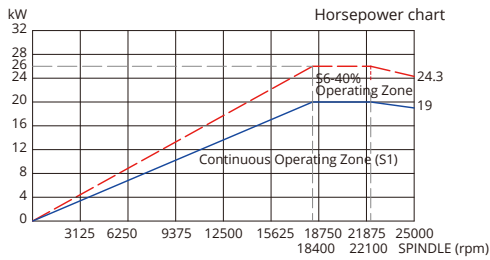

METAL MACHINING / IN-LINE SPINDLE

> 12.000 rpm > Heidenhain 640 controller | Heidenhain QAN200UH 10/14 kW

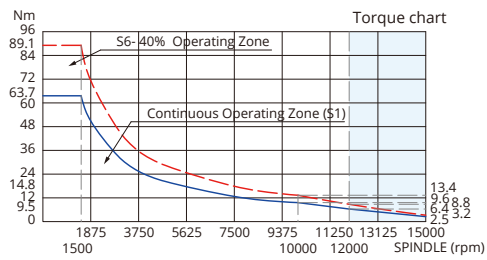
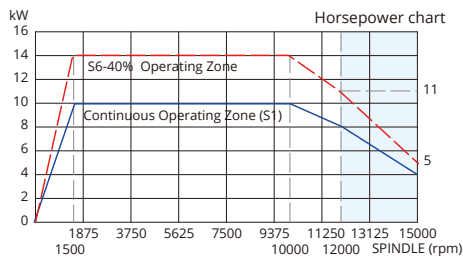

> 12.000 rpm > Siemens 840D controller | Siemens 1PH8107-1SG02-3LA1 10.5/15.8 kW

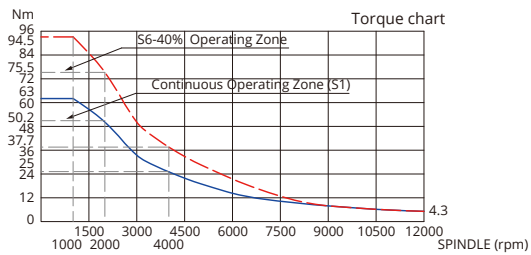
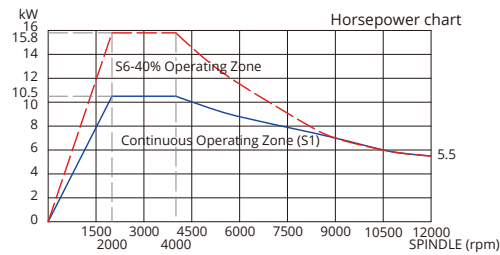

> 12.000 rpm > Fanuc 31iB controller | Fanuc AiT12 11/15 kW

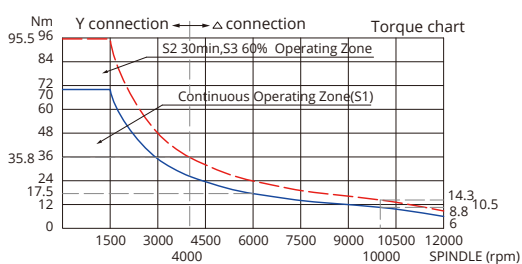
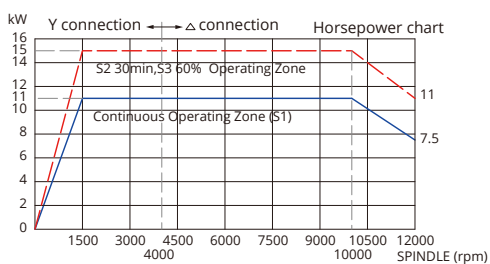

> 15.000 rpm > Heidenhain 640 controller | Heidenhain QAN200UH 10/14 kW

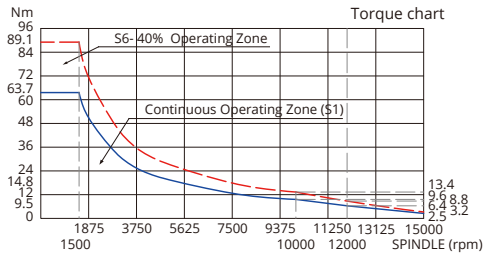
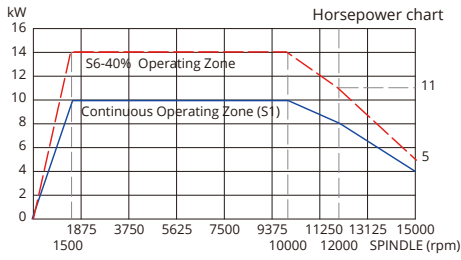

> 15.000 rpm > Siemens 840D controller | Siemens 1PH8107-1SS02 8.5/12.8 kW

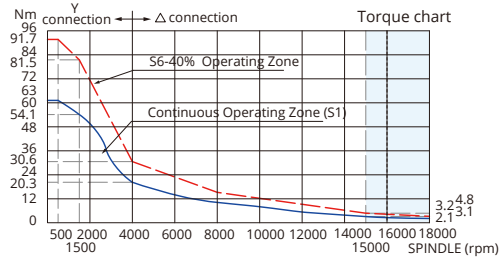
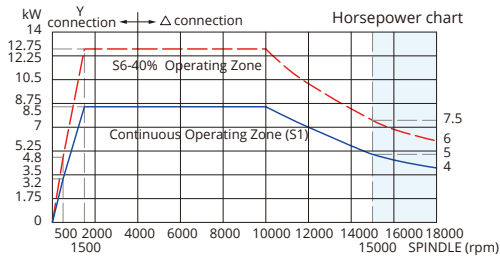

> 15.000 rpm > Fanuc 31iB controller | Fanuc AiT15 15/18.5 kW

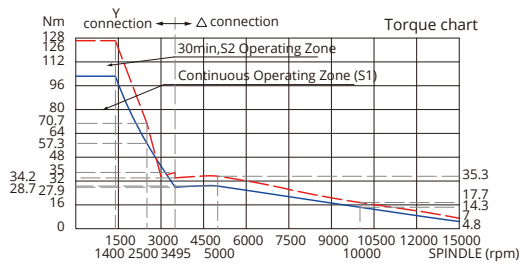
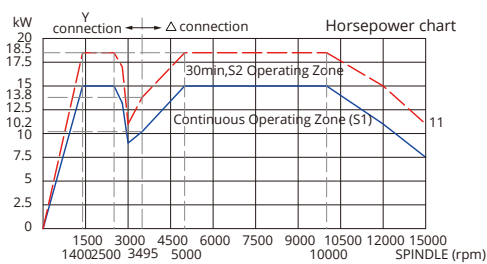

METAL MACHINING / HIGH SPEED BUILT-IN SPINDLE

> 14.000 rpm (Grease) | 18.000 rpm (Air/Oil) > 15/18 kW

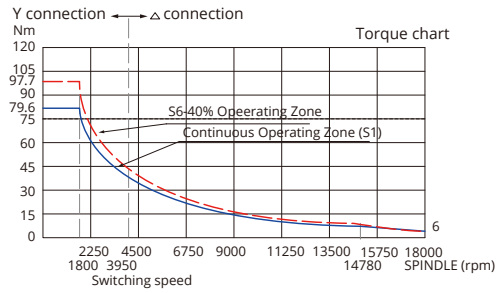
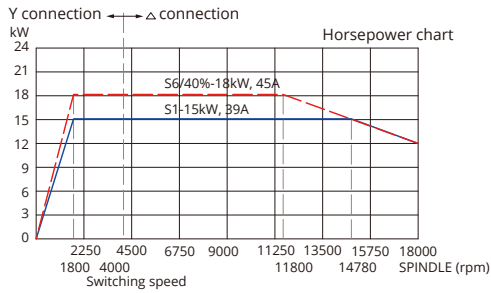

> 24.000 rpm > 20/25 kW

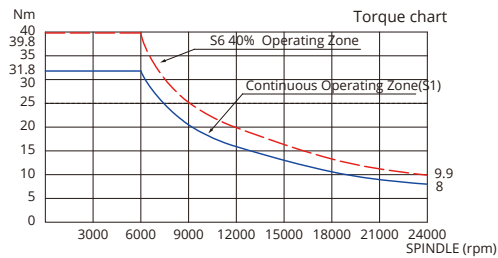
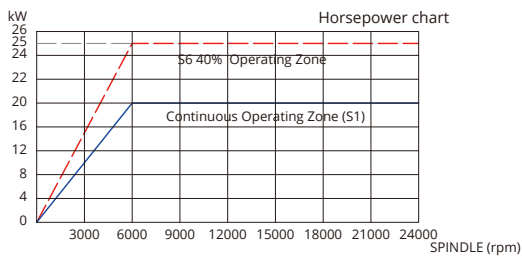

> 36.000 rpm > 20/26 kW

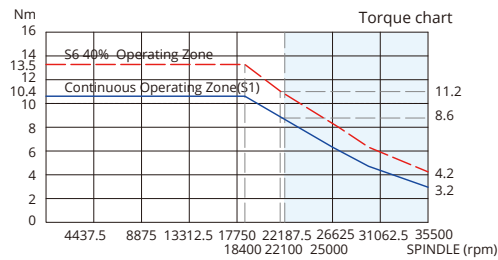
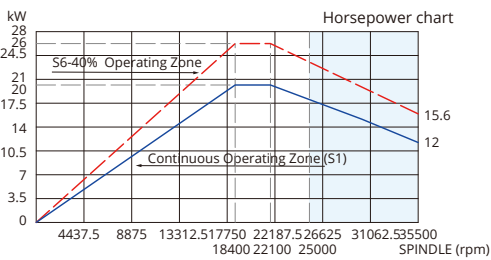

CHIP & TOOL MANAGEMENT

FLUSHING CHIPS AWAY

Metal

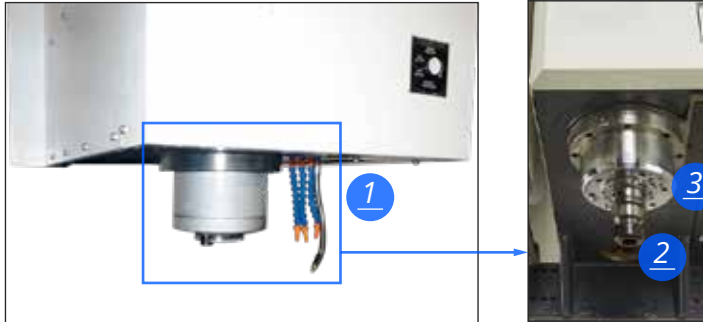

- 1 Chip flushing
- 2 Coolant through spindle
- 3 Coolant at spindle

Graphite

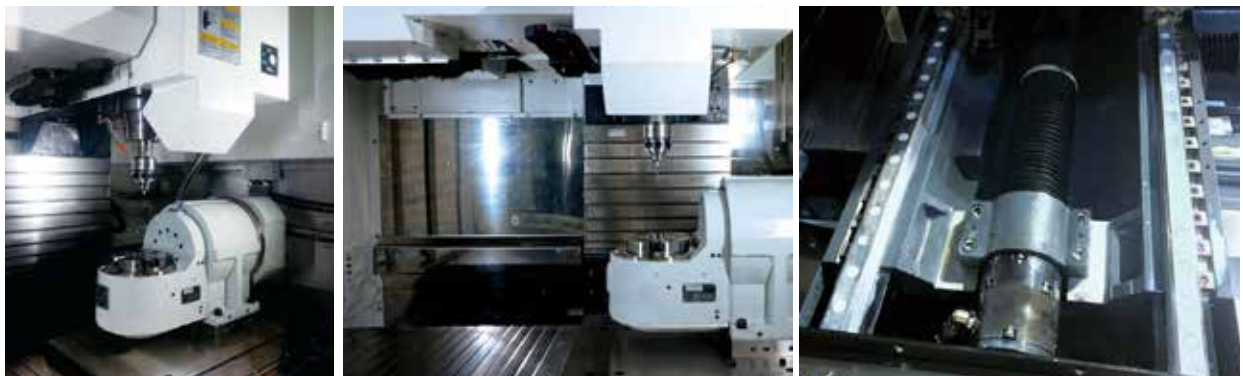

Dust suction hose

Airflow Capacity: Max 4000 m³/h
Dust Collector Capacity: 205 L

Dust suction hose and
graphite telescopic covers

Ballscrew and guideways
below telescopic cover

TOOL MAGAZINE SELECTION FOR EVERY APPLICATION



1
Cam mechanism and electric motor drive

Fast Tool Change Time of 1.55 (50Hz) and 1.31 (60Hz) sec

2
Tools are easily accessible by operator

Surveillance and maintenance of tools is possible while machine is in automatic mode

ERGONOMICS

ACCESSIBILITY TO WORK AREA AND FOCUS ON THE OPERATOR



Wide opening of front door. Complete roof integrated in the door. Over-head crane reaches table center

Easy access, loading and unloading of bulky and heavy workpieces



Standard scraper-type lift conveyor in front of the Metal type V5X machine body

Chip bucket can easily be reached from the machine front

Swivelling control panel on the right side

Comfortable operator usage and compact design

All necessary consumables are located in the back for convenient checking and tank re-filling

Easier maintenance routine for operator

Large dust collection bins in the front of Graphite type V5X machine body

Easy to pull out and empty the falling dust



AUTOMATION

Loader

- > Max Workpiece Capacity: 84 places for workpieces
Dimension: 100x100x100 mm
- > Option: 16 places for workpieces
Dimension: Ø200x250 mm + 42 places for workpieces
Dimension: 100x100x100 mm
- > Max Workpiece Loading: 8 kg



Loader loading accessibility



CONTROL UNIT

A CONTROLLER FOR EVERY USER

Heidenhain TNC 640

- > Kinematics
- > Dynamic Collision Monitoring
- > Tool Center Point Management
- > Tilted the Working Plane

Heidenhain TNC 640

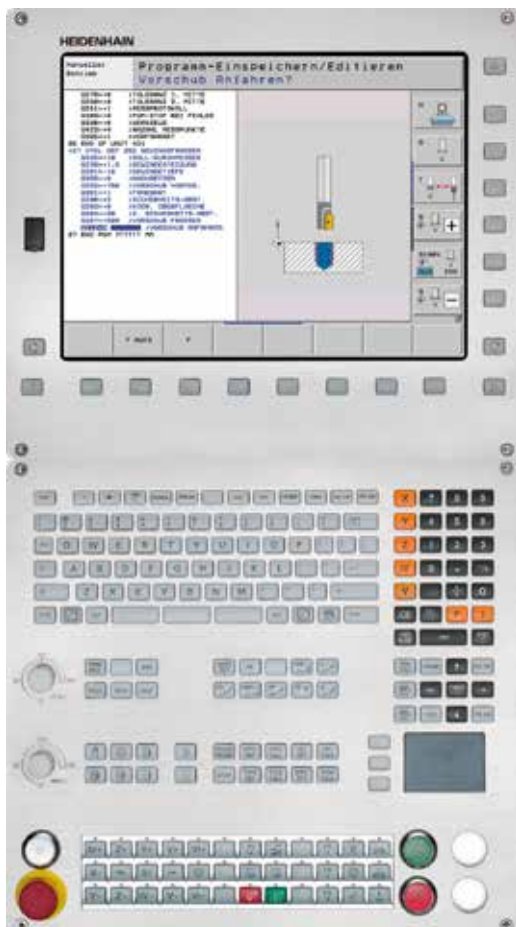

Siemens 840D SL/SINUMERIK ONE

- > Kinematics chain
- > Collision Avoidance
- > 5-axis transformation with tool orientation
- > Swivel the Coordinate System

Fanuc 31i-B5 plus

- > 3D Interference Check
- > High Speed Smooth TCP
- > Tilted Working Plane indexing

Siemens 840D SL



Fanuc 31i-B5 plus



STANDARD & OPTIONAL EQUIPMENT

Standard details of a premium machine

Electrical cabinet in the right side of machine

Improves the layout as the back of the machine can be place close to wall



Cooling units options for Metal Machining:

- > CTS 40 bar built-in type
- > CTS 70 bar Separate type (Option)
- > CTS 40 bar Separate type with Ppaper filter + Coolant chiller (Option)
- > CTS 70 bar Separate type with Paper filter + Coolant chiller (Option)
- > CTS 70 bar programmable Separate type with Paper filter + Coolant chiller (Option)

Recommended for high aluminum or cast iron material cutting



Customize the machine to your needs

Chain-type chip conveyor and high pressure (70 bar) coolant through spindle

Machine is prepared for every machining operation



TECHNOLOGIES

SMT™

SMART MACHINING TECHNOLOGY

As pioneers of advanced mechatronic systems with decades of R&D expertise, AXILE has taken 5-axis CNC machining to the next level. Our patented SMT™ (Smart Machining Technology) delivers groundbreaking compensation and calibration functionality for unrivaled cutting speeds and industry-leading accuracy, and more importantly, resolves the aforementioned issues created by thermal expansion.

With AXILE's SMT™ manufacturers can have it all. There's no longer the need to choose between speed and precision, meaning manufacturers can produce superior parts rapidly, while also securing total process reliability and long-term machining performance.



Axial Accuracy Control



- > **AXIAL THERMO MONITORING**
Integration of temperature sensors and thermal error model
- > **HIGH PRECISION**
Thermal induced positioning error compensation

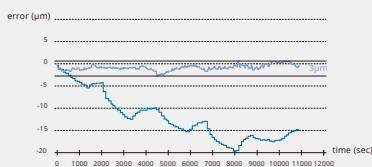

THERMAL ERROR BEFORE AND AFTER COMPENSATION
With thermal compensation system, the thermal error can be reduced from 20µm to 3µm.



Tool-tip Positioning Control



- > **HIGH ACCURACY**
Directly measuring expansion
- > **BETTER SURFACE FINISH**
5~6 times accuracy improved
- > **REAL-TIME COMPENSATION**
Electrical type sensor

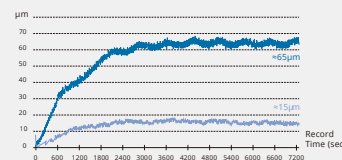

With compensation, the displacement of tool tip is reduced from 65µm to 15µm.

ACCURACY IMPROVED 5~6 TIMES!



Spindle Vibration Supervision

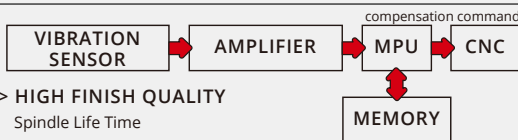

- > **HIGH FINISH QUALITY**
Spindle Life Time
- > **LONGER LIFE TIME**
Wear reduction on spindle bearings and tools
- > **EASY FOR MAINTENANCE**
Up to 12000 abnormal vibration data recording

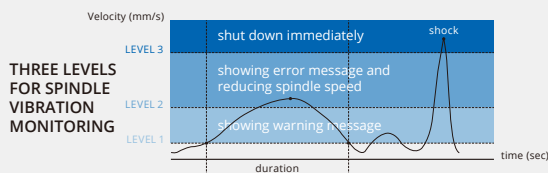

THREE LEVELS FOR SPINDLE VIBRATION MONITORING



Metal Removal Rate Optimization

- > **OPTIMIZATION PRODUCTION**
Fully utilize machine capability
- > **EXTREMELY FAST PROCESSING TIME**
Maximization of metal removal rate
- > **HIGH TOOL DURABILITY & PERFECT SURFACE ROUGHNESS**
Stable cutting force and chatter-free machining
Surface Roughness improved **61.5%**
Spindle load decrease **13.6%**

INTELLIGENT MONITORING SYSTEM

The future of manufacturing depends on optimized, intelligent production. To gain an edge on the competition, embracing smart manufacturing is the best way to stay ahead of the curve.

To deliver agile smart machining, and that all-important competitive edge, we have created ART™, an intelligent monitoring system that enables 24/7 operations and eliminates unexpected downtime. ART™ monitors all wearing components, energy consumption, and fluids such as lubricant and coolant, to supply real-time status updates on the machine and its components, and to pre-empt future issues.

Utilizing ART™ in daily operations immediately improves production efficiency by empowering machinists to make informed decisions. Moreover, ART™ gives manufacturers the reassurance required to embrace automation solutions, by delivering vital oversight through total operational transparency.

ART™ framework

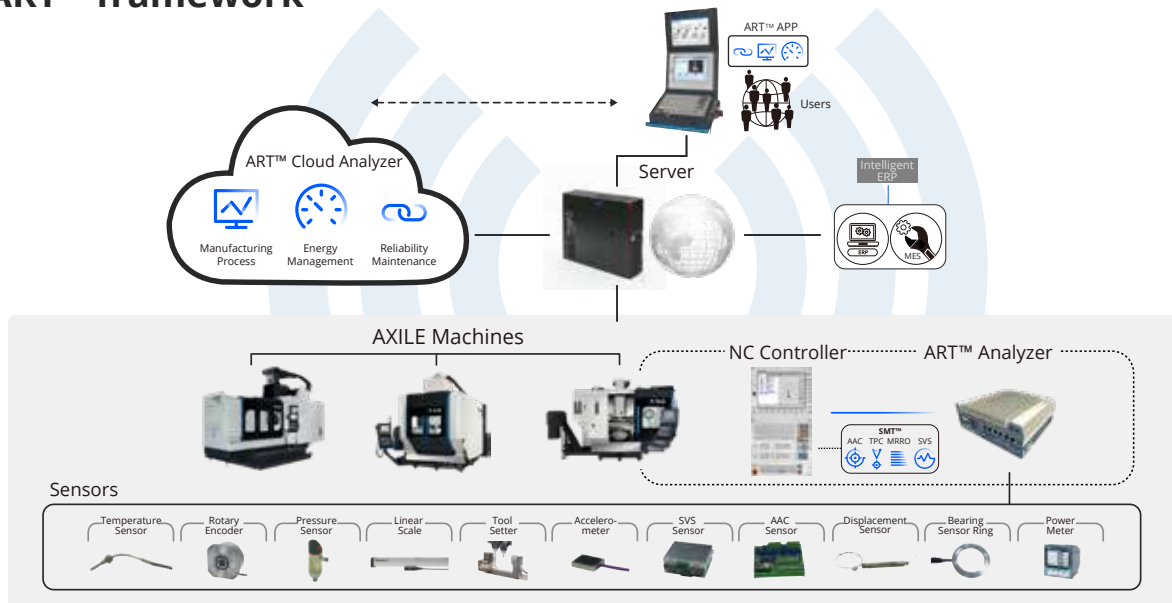

3 Core Functions to Boost Productivity & Profitability



Reliability Maintenance (RM)

Unexpected downtime is the enemy of profitability. ART™ delivers machine components diagnosis, machine lifetime estimation, and consumable supplies monitoring to pre-empt machine failure and eliminate unplanned downtime.



Manufacturing Process (MP)

Knowledge is power. ART™ achieves superior data collection and analytics on machine status and utilization rates, to deliver real-time information for optimized production strategies.



Energy Management (EM)

Every penny counts. ART™ enables manufacturers to monitor their power consumption, to identify ways to maximize energy efficiency and reduce expenditure.

Industry 4.0 Solutions to Intelligent Machine

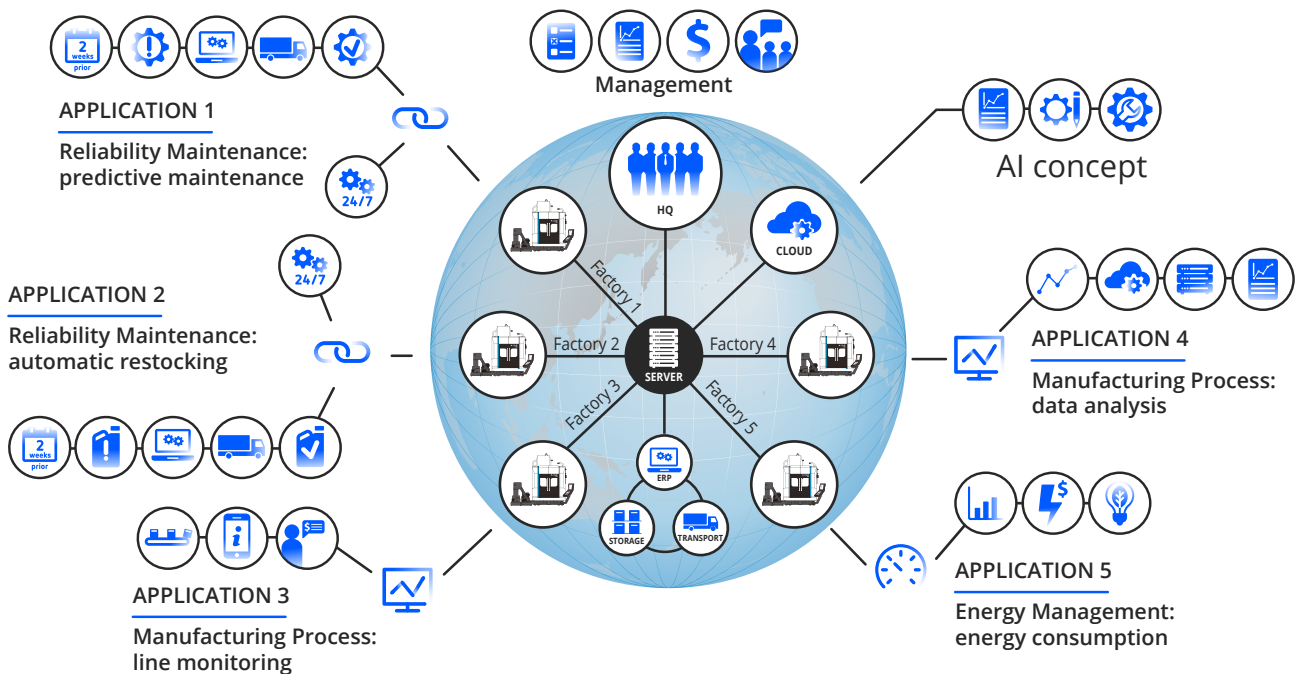

How ART™ Brings Production Benefits

- > Clearly displays machine status, for quick decision-making
- > Maximizes machine accessibility and utilization, for optimized production
- > Provides real-time notification of abnormal conditions, for swift intervention
- > Gives machinists the information required to optimize removal rates and machine lifetime

How ART™ Brings Maintenance & Service Benefits

- > Delivers pre-emptive error messages prior to breakdown, to eliminate unexpected downtime
- > Decreases service expenses, by precisely identifying the issue
- > Enhances service efficiency, by recommending appropriate action
- > Reduces spare parts inventory, by highlighting exactly what is needed and when
- > Automatically orders new parts, by linking to online purchasing system
- > Allows machines and equipment to remain on stand-by, always ready to work

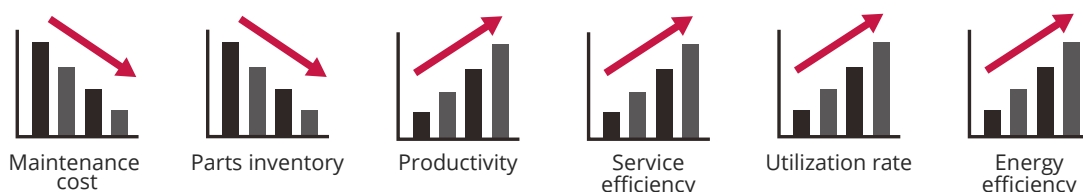

TECHNICAL DATA

BASIC PARAMETERS

ROTARY AND TILTING TABLE			
Table size	Ø170 mm	Ø6.7 in	
T-solt (w/pitch/no)		14H8	
Maximun table load	30 kg	66 lbs	
LINEAR AXES			
X travel (carriage left and right)	600 mm	23.6 in	
Y travel (gantry back and forth)	500 mm	19.7 in	
Z travel (headstock up and down)	435 mm	17.1 in	
Max feedrate X/Y/Z	40 m/min	1575 in/min	
ROTARY & SWIVELLING AXES			
Swiveling axis A		±120 deg	
Rotary axis C		360 deg	
Max speed axis A		100 rpm	
Max speed axis C		200 rpm	
IN-LINE SPINDLE (METAL MACHINING)			
Spindle taper		ISO40	
Maximum speed		12000(std) ; 15000 rpm (opt)	
Power S1/S6-40% (Heidenhain)	10/14 kW	13.5/19 hp	
Torque S1/S6-40% (Heidenhain)	63.7/89.1 Nm	47/65.7 Ft/lbs	
Power S1/S6-40% (Siemens)	10.5/15.8 kW (12K)	14/21.1 hp (12K)	
	8.5/12.8 kW (15K)	11.3/17.1 hp (15K)	
Torque S1/S6-40% (Siemens)	63/94.5 Nm (12K)	46.4/69.7 Ft/lbs (12K)	
	63/91.7 Nm (15K)	46.4/67.6 Ft/lbs (15K)	
Power S1/S6-40% (Fanuc)	11/15 kW (12K)	14.7/20.1 hp (12K)	
	15/18.5 kW (15K)	20.1/24.8 hp (15K)	
Torque S1/S6-40% (Fanuc)	70/95.5 Nm (12K)	51.6/70.4 Ft/lbs (12K)	
	102.7/126 Nm (15K)	75.7/92.9 Ft/lbs (15K)	
Spindle nose to rotary & swivelling table	100-535 mm	3.93-21.1 in	
BUILT-IN SPINDLE (METAL MACHINING)			
Spindle taper		HSK E50/A63	
Maximum speed		14000 rpm (Grease) ; 18000 rpm (Air/Oil) ; 24000 rpm ; 36000 rpm	
Power S1/S6-40%	15/18 kW	15/18 kW	20/25 kW
	20.1/24.1 hp	20.1/24.1 hp	26.8/33.5 hp
Torque S1/S6-40%	79.6/97.7 Nm	79.6/97.7 Nm	31.8/39.8 Nm
	58.7/72 Ft/lbs	58.7/72 Ft/lbs	23.4/29.3 Ft/lbs
Spindle nose to rotary & swivelling table	100-535 mm	3.93-21.1 in	
BUILT-IN SPINDLE (GRAPHITE MACHINING)			
Spindle taper		HSK E50	
Maximum speed		25000 rpm	
Power S1/S6-40%	20/26 kW	26/35 hp	
Torque S1/S6-40%	10.4/13.5 Nm	7.67/9.96 Ft/lbs	
Spindle nose to rotary & swivelling table	100-535 mm	3.93-21.1 in	
TOOL CHANGER			
Magazine positions		32/40	
Change time T-T (50/60 Hz)		1.55/1.31 sec	
Maximum tool length	300 mm	11.8 in	
Maximum tool diameter (with adjacent pot empty)	Ø75/Ø125 mm	Ø2.95/Ø4.92 in	
Maximum tool weight	7 kg	15.4 lbs	
Maximum loading weight	160 kg(32T) ; 200 kg (40T)	1575 in/min	
ROTARY ACCURACY			
A axis Positioning		±5 arc-sec	
C axis Positioning		±2 arc-sec	
CONTROL UNIT			
Heidenhain		TNC 640	
Siemens		840D SL	
Fanuc		31i-B5 Plus	

* Specifications are subject to change without notice.

CONSTRUCTION DETAILS

LINEAR AXES		
Linear guideways type		Roller type
Linear guideways size X/Y/Z	35 mm	1.4 in
Distance between X/Y/Z axis guides	360/700/400 mm	14.2/27.6/15.7 in
BALLSCREW		
Ballscrew diameter/pitch	40 x P16 mm	1.6 x P0.6 in
X axis motor power/torque (Heidenhain)	2.64 kW ; 8.4 Nm	3.5 hp ; 6.1 Ft/lbs
Y axis motor power/torque (Heidenhain)	2.64 kW ; 8.4 Nm	3.5 hp ; 6.1 Ft/lbs
Z axis motor power/torque (Heidenhain)	5.4 kW ; 17.3 Nm	7.2 hp ; 12.7 Ft/lbs
X axis motor power/torque (Siemens)	2.7 kW ; 12 Nm	3.6 hp ; 8.8 Ft/lbs
Y axis motor power/torque (Siemens)	2.7 kW ; 12 Nm	3.6 hp ; 8.8 Ft/lbs
Z axis motor power/torque (Siemens)	4.9 kW ; 27 Nm	6.5 hp ; 19.9 Ft/lbs
X axis motor power/torque (Fanuc)	2.2 kW ; 8 Nm	2.9 hp ; 5.9 Ft/lbs
Y axis motor power/torque (Fanuc)	2.2 kW ; 8 Nm	2.9 hp ; 5.9 Ft/lbs
Z axis motor power/torque (Fanuc)	4 kW ; 22 Nm	5.3 hp ; 16.2 Ft/lbs
TOOL CHANGER		
Change type		Arm type
MEASURING FEEDBACK		
Linear axes type		Linear scales
Linear axes resolution		0.1 μ m
Rotary axes type		Angle Encoder
Indexing accuracy		\pm 5 arc-sec
DIMENSION		
Length (without chip conveyor)	2300 mm	7.54 ft
Width	2300 mm	7.54 ft
Height	3070 mm	10.07 ft
Weight	6560 kg	14462 lbs
Floor space	2300 x 2300 mm	7.54 x 7.54 ft

* Specifications are subject to change without notice.



AXILE MACHINE

E info@axilemachine.com

W www.axilemachine.com

©2021 AXILE. All rights reserved.